

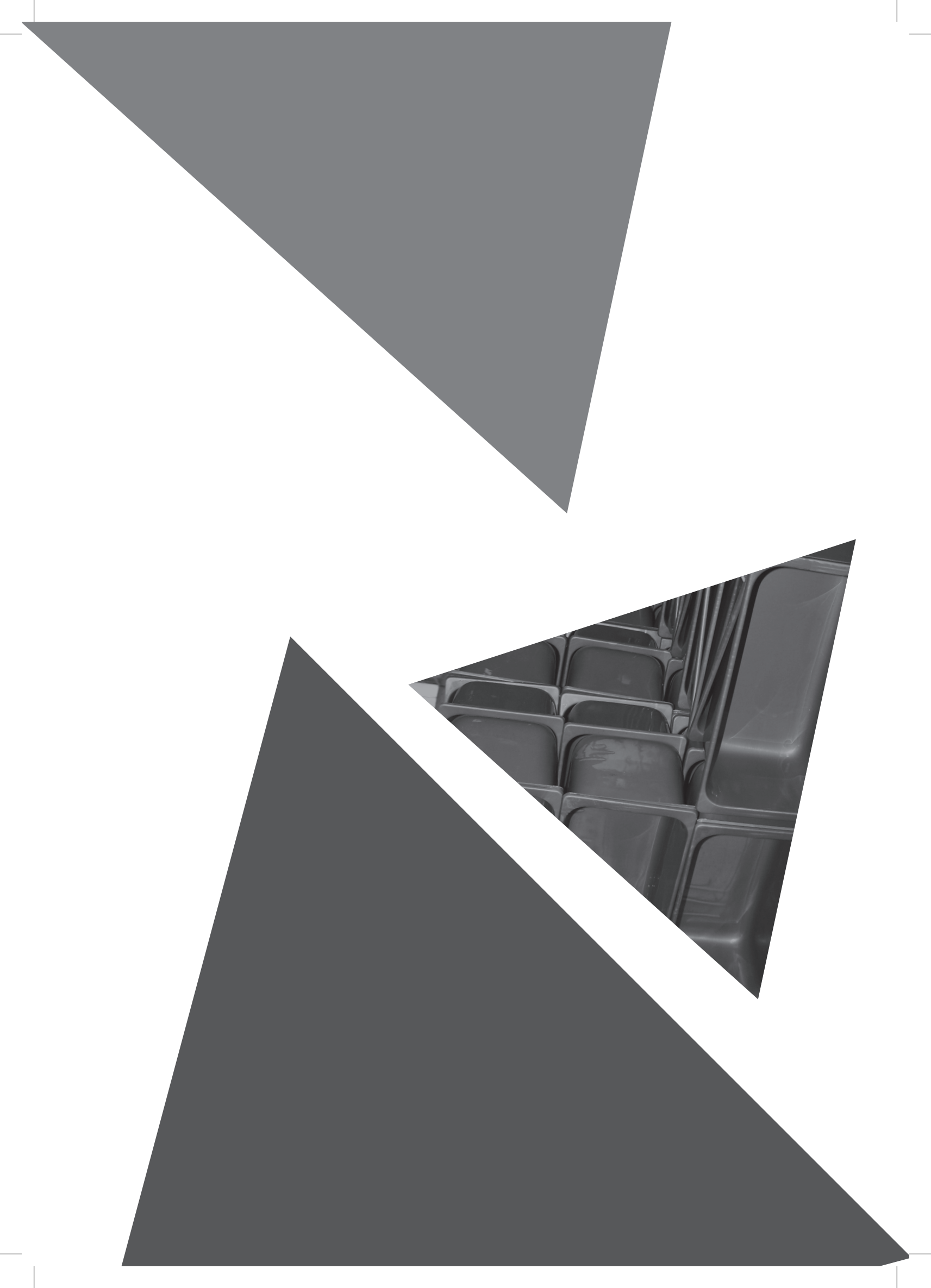

Stainless steel professionals





L' Azienda

The Company

Il 4 Aprile 1960 nasce ASIT:
Attrezzature, Stampi, Imbutitura, Tranceria.

Abbiamo il merito e la responsabilità di essere stati i primi a rivoluzionare con le nostre vaschette i banchi delle gelaterie, costruendo a stampaggio imbutito, risolvendo così problemi costruttivi e di igiene.

Sicuramente oggi ASIT ha un know-how unico in Europa, in grado di soddisfare le esigenze di qualsiasi arredo. L'esperienza maturata in 50 anni di attività nell'imbutitura dell'acciaio inox, consente di proporre sia una vasta gamma di prodotti standard che realizzazioni specifiche in base alle esigenze del Cliente.

In tutto sono 6 le nostre collezioni di articoli, all'interno delle quali si aprono delle ulteriori categorie. Gelateria, Gastronorm, Polycarbonato, Lavelli, Vassoi, Complementi.

Tenace sostenitrice del Made in Italy, ASIT continua a produrre nello stabilimento di Monteroni d'Arbia, ed offre a prezzi competitivi un prodotto di altissima qualità, curato nei minimi dettagli, come è sempre stato nella nostra tradizione.

4th April 1960, ASIT is born: Attrezzature, Stampi, Imbutitura, Tranceria.

We have both the merit and the responsibility to have been the first to revolutionize the ice-cream display cases, by realizing our pans through deep-drawing process. This allowed to solve manufacturing and hygiene issues.

ASIT's know-how, an unique one in Europe, is surely able to satisfy the needs of any furniture. Our experience, gathered in 50 years of activity in the field of stainless steel deep-drawing, allows us to offer both a wide range of standard products and specific realizations based upon customer's requests.

Our items are arranged in 6 different sets: Ice-cream, Gastronorm, Polycarbonate, Sink bowls, Trays, Stainless steel trolleys.

Strongly supporting the "Made in Italy", ASIT keeps manufacturing in its plant located in Monteroni d'Arbia (near Siena), and offers at competitive prices very high quality products, carefully designed to the most minute details, as it has always been in our tradition.





Gelateria	9
<i>Ice-cream</i>	
Gastronomia	21
<i>Gastronorm</i>	
Policarbonato	29
<i>Polycarbonate</i>	
Lavelli	35
<i>Sink bowls</i>	
Vassoi	41
<i>Trays</i>	
Complementi	45
<i>Accessories</i>	

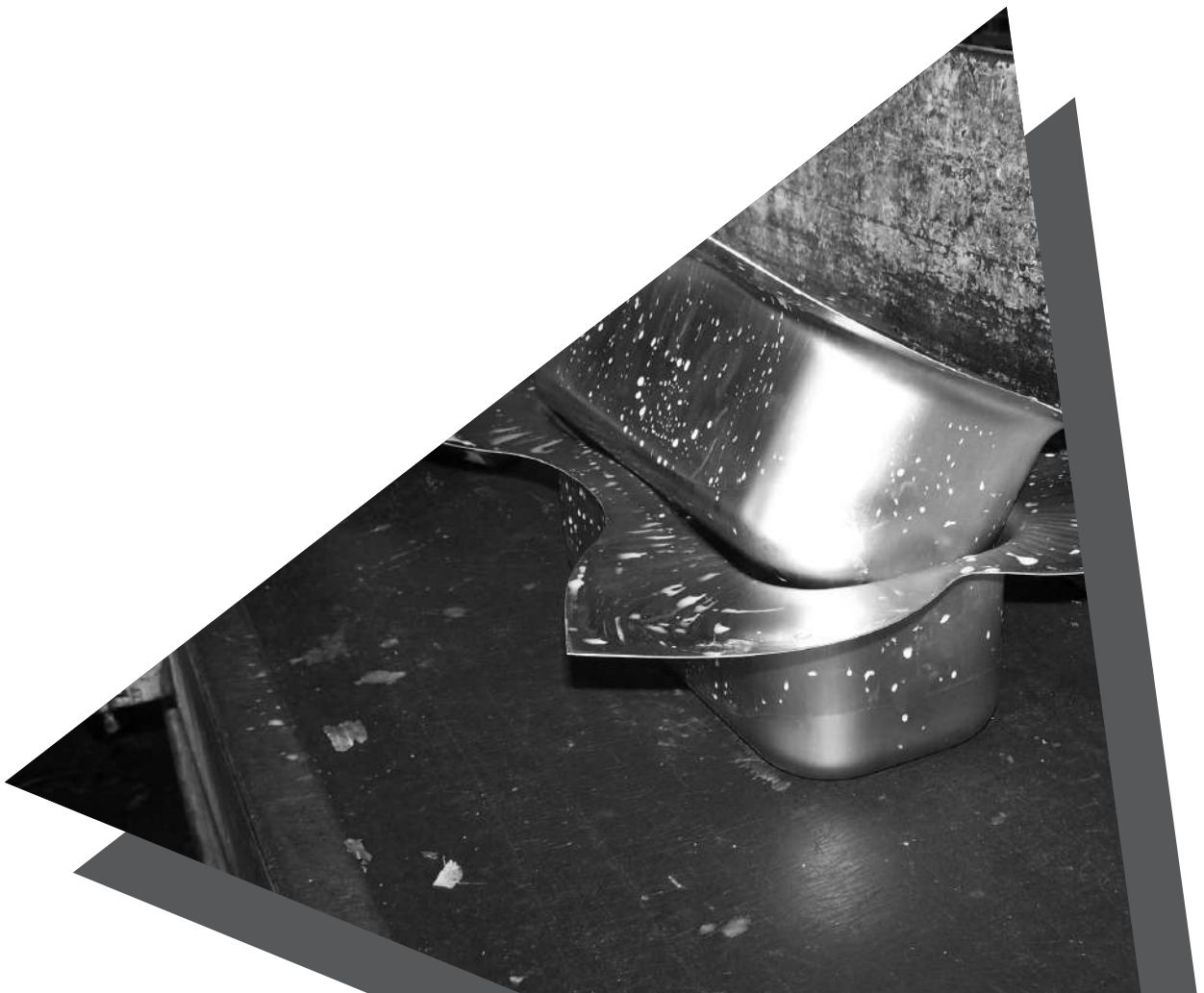
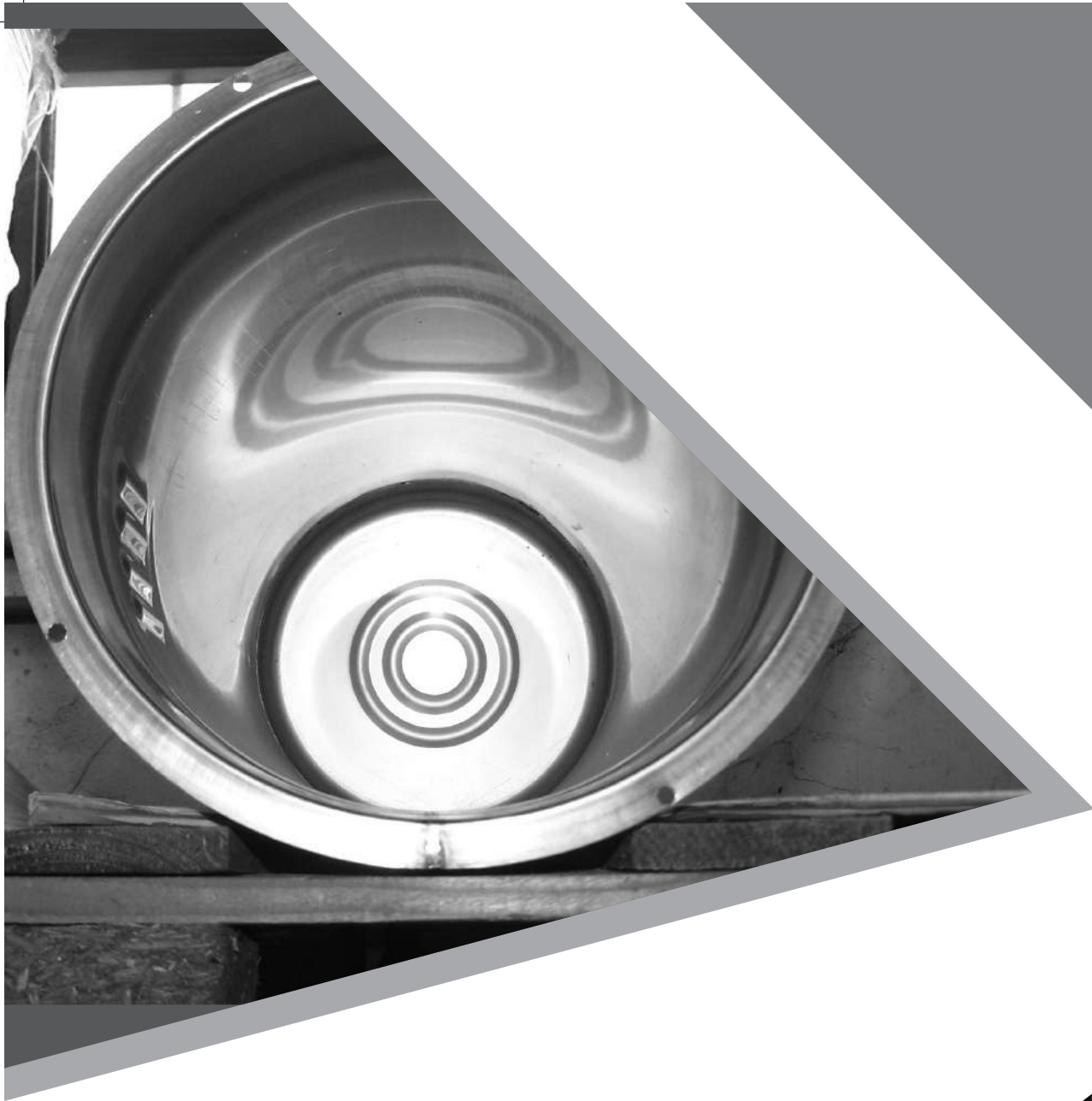



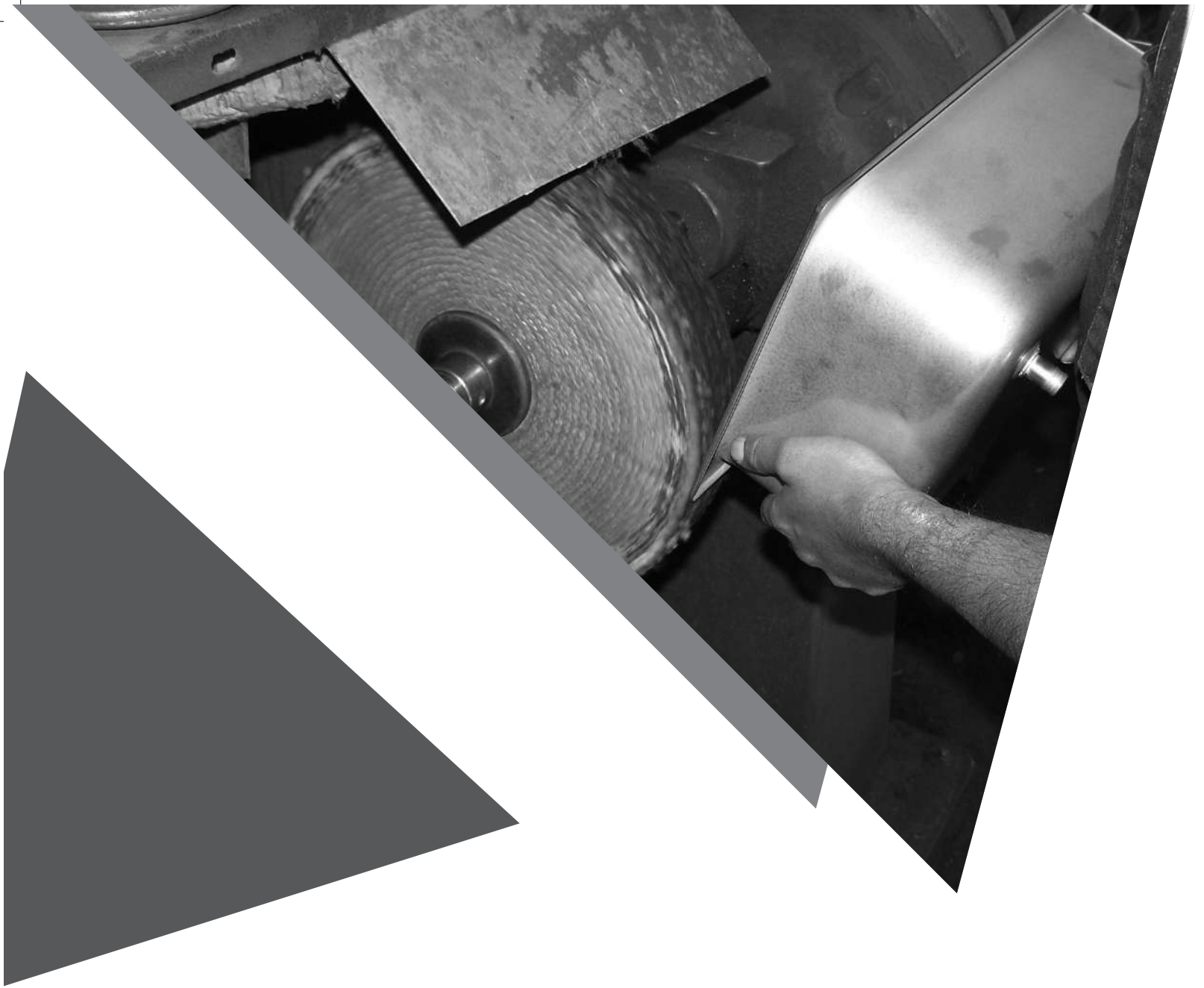



Fatto da Noi. Fatto a Siena

Made by Us. Made in Siena

In 50 anni di operoso e attivo lavoro,
Asit garantisce al cliente un prodotto fatto con il cuore.

Orgogliosi di portare nel futuro questa tradizione tutta
Italiana, noi di Asit siamo consapevoli di aver contribuito
con il nostro operato al successo di molte Aziende.

*In 50 years of intense and active work,
Asit guarantees to the customer a product that is made with
the heart.*

*Proud to carry forward this all Italian tradition, we are aware
that Asit has contributed, with its action, to the success of
many Companies.*



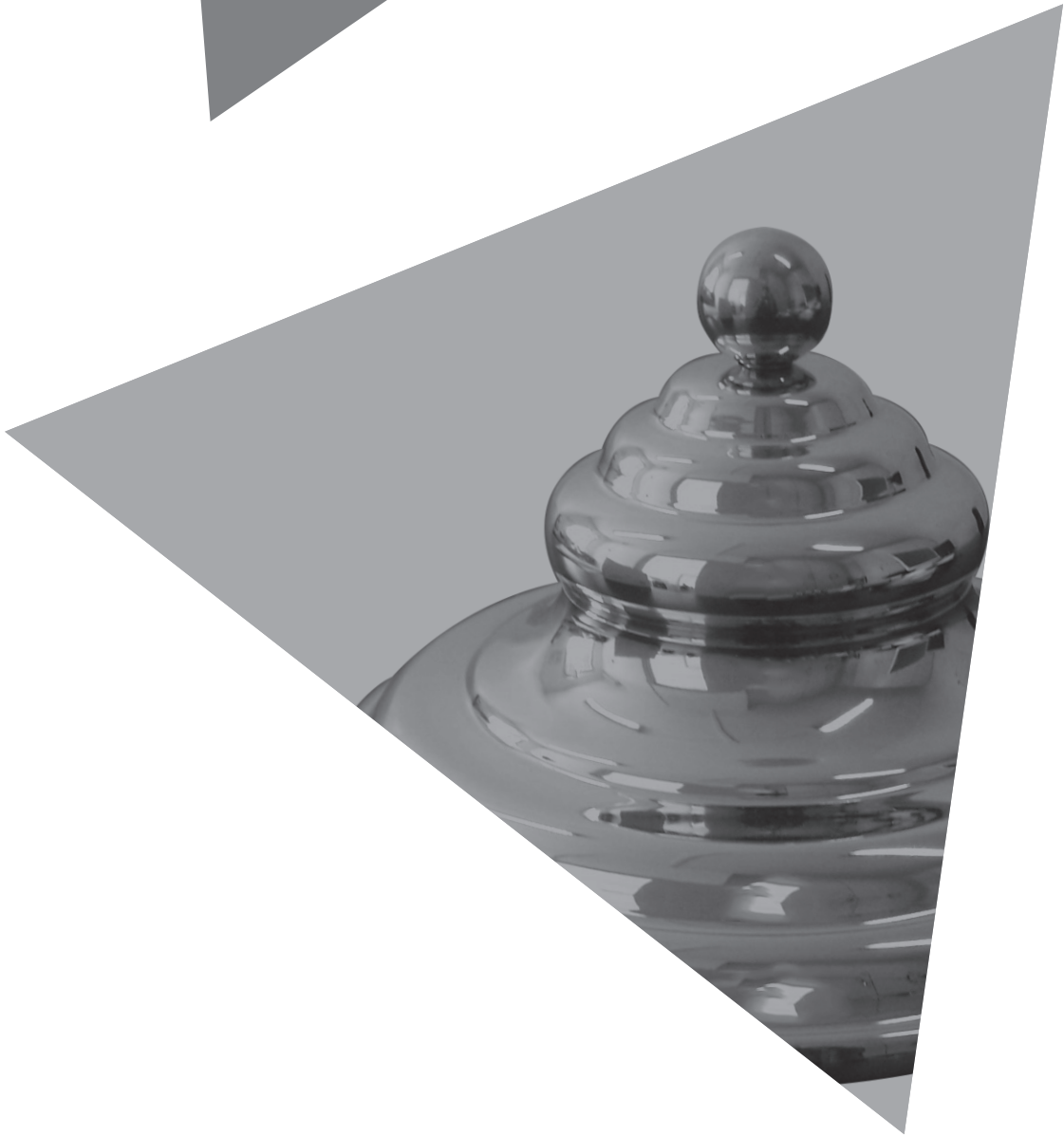



Gelateria

Ice-cream

La serie Gelateria di Asit si compone di diverse famiglie di prodotti.

A partire dalle vaschette standard in acciaio inox ed in policarbonato per arrivare alle vaschette speciali ideate per banchi curvi.

Grande attenzione è rivolta anche alle carapine, con coperchi ermetici dal design innovativo.

Lo spazio dedicato ai lavaporzionatori propone sia gli articoli assemblati che le varie singole componentistiche.

Palette, coperchi in policarbonato e plexiglass ed altri accessori completano la serie gelateria.

Our range of ice-cream containers and accessories is made by different types of products.

They vary from standard stainless steel and polycarbonate containers to special containers designed for curved display cases.

We also pay great attention to the cylindrical containers (known as carapine) and to the hermetical lid with its innovative design.

The category dedicated to the scoop washers offers both assembled items and all the spare parts.

Spatulas, polycarbonate lids and other accessories complete the range.

Codice	A mm	B mm	H mm	Capacità
--------	------	------	------	----------

CONTENITORI IN ACCIAIO PER GELATERIA STAINLESS STEEL ICE-CREAM PANS

VSC01	165 esterno (150 interno) <i>165 external (150 internal)</i>	165 esterno (130 interno) <i>165 external (130 internal)</i>	120 150	2.5 lt 3 lt
-------	--	--	------------	----------------



VSC03	330 esterno (300 interno) <i>330 external (300 internal)</i>	165 esterno (150 interno) <i>165 external (150 internal)</i>	80 120 150 180	3.4 lt 5 lt 7 lt 9 lt
-------	--	--	-------------------------	--------------------------------



VSC11	330 esterno (300 interno) <i>330 external (300 internal)</i>	250 esterno (235 interno) <i>250 external (235 internal)</i>	80 120 150 180	4.6 lt 7 lt 10 lt 13 lt
-------	--	--	-------------------------	----------------------------------



VSC05	330 esterno (315 interno) <i>330 external (315 internal)</i>	330 esterno (300 interno) <i>330 external (300 internal)</i>	120	11 lt
-------	--	--	-----	-------



VSC02	180 esterno (150 interno) <i>180 external (150 internal)</i>	165 esterno (150 interno) <i>165 external (150 internal)</i>	120	2.7 lt
-------	--	--	-----	--------



Codice	A mm	B mm	H mm	Capacità
--------	------	------	------	----------

VSC04	360 esterno	165 esterno	80	3.5 lt
	(330 interno)	(140 interno)	120	5 lt
			150	7 lt
			180	8 lt
	<i>360 external</i>	<i>165 external</i>		
	<i>(330 internal)</i>	<i>(140 internal)</i>		



VSC10	360 esterno	250 esterno	80	5.4 lt
	(332 interno)	(227 interno)	120	8 lt
			150	11 lt
			180	14 lt
	<i>360 external</i>	<i>250 external</i>		
	<i>(332 internal)</i>	<i>(227 internal)</i>		



VSC06	420 esterno	200 esterno	150	10 lt
	(400 interno)	(180 interno)	170	12 lt
			200	14 lt
			250	18 lt
	<i>420 external</i>	<i>200 external</i>		
	<i>(400 internal)</i>	<i>(180 internal)</i>		



VSC07	210 esterno	200 esterno	150	5 lt
	(190 interno)	(180 interno)	170	5.5 lt
			200	6.5 lt
	<i>210 external</i>	<i>200 external</i>		
	<i>(190 internal)</i>	<i>(180 internal)</i>		



VSC08	258 esterno	157 esterno	120	3.4 lt
	(235 interno)	(135 interno)	150	4.25 lt
			170	5 lt
	<i>258 external</i>	<i>157 external</i>		
	<i>(235 internal)</i>	<i>(135 internal)</i>		



Codice	A mm	B mm	H mm	Capacità
--------	------	------	------	----------

CONTENITORI SPECIALI PER GELATERIA

SPECIAL PANS FOR ICE-CREAM

TRAP	esterno 186x360x144	120	5 lt
	(interno 171x330x129)	150	7 lt

Vasca trapezoidale per banchi curvi
external 186x360x144
(internal 171x330x129)
Trapezoidal pan for curved display cases



TRG33	Lato 330	120	4 lt
	<i>Length 330</i>		

TRG36	Lato 360	120	4.5 lt
	<i>Length 360</i>		

Vaschetta triangolare
Triangular pan



VSC/210	esterno diam. 235 mm	100	3 lt
	(interno diam. 210 mm)		

Sono disponibili anche il coperchio e la vaschetta in altezza 140 mm.
external diam. 235 mm
(internal diam. 210 mm)

Round pan
We can also provide the lid and the pan in 140 mm. depth.



CARAPINA

CV00	Carapina inox ø200	250
	<i>Stainless steel "carapina"</i>	

CV00/AR	Carapina inox ø200	250
	Con sistema "anti-rotazione"	
	<i>Stainless steel "carapina", fitted with "anti-rotation" system</i>	

CV00/125	Carapina inox ø 200 x 125
	(disponibile anche con sistema "anti-rotazione")
	<i>(available also with "anti-rotation" system)</i>

Coperchio plastica per carapina
Plastic lid for carapina

CV01P	Coperchio ø 200 in plastica, per carapina
	<i>ø200 plastic lid for carapina</i>



Codice	A mm	B mm	H mm
--------	------	------	------

POZZETTI PER CARAPINE CYLINDER FOR CARAPINA

CV00/C Anello h. 70 mm. per pozzetti ø210
Ring, 70 mm high, for ø 210 cylinders

CV00/P Pozzetto inox ø 210 mm. 510
predisposto per sistema "anti-rotazione"
*Cylinder, 510 mm. high, ø 210mm,
fitted with anti-rotation system*

CVOO/P25 Pozzetto inox ø 210 mm. 260
predisposto per sistema "anti-rotazione"
*Cylinder, 260 mm. high, ø 210mm,
fitted with anti-rotation system*



COPERCHIO ERMETICO PIATTO PER POZZETTI HERMETIC FLAT LID

CV 01

Finitura struttura a vista: inox
Diametro chiusura ermetica: 210 mm
Struttura ermetica inferiore (ad incasso) realizzata in acciaio inox AISI 304, coibentazione con materiale termoisolante.
*It fits on the ring for cylinders for carapina.
Finishing of external structure: stainless steel.
Diameter of hermetical closure: 210 mm.
Lower hermetic structure made in AISI 304 stainless steel, insulated with foam.*



COPERCHI PIRAMIDALI PER POZZETTI PYRAMIDAL LID, NON-HERMETIC

CV 02

Altezza: 133 mm. - Diametro: 240 mm.
Struttura superiore a campana totalmente realizzata in ottone, con finitura a scelta cromata o dorata
A richiesta è disponibile anche una versione con diametro 300 mm. e 370 mm.
*Height: 133 mm. Diameter: 240 mm.
Upper structure, bell-shaped, completely made in brass.
Finishings available: chrome or gold colour.
The ø300 and ø370 versions are available upon request.*



COPERCHI ERMETICI PIRAMIDALI PER POZZETTI PYRAMIDAL LID, HERMETIC

CV 02/E

Diametro chiusura ermetica: 210 mm
Altezza totale: 170 mm (parte superiore H.133 mm. - parte inferiore H. 37 mm)
Struttura superiore a campana totalmente realizzata in ottone, con finitura a scelta cromata o dorata.
Struttura ermetica inferiore (ad incasso) realizzata in acciaio inox AISI 304, coibentazione con materiale termoisolante.
*Diameter of hermetical closure: 210 mm.
Total height: 170 mm (Upper structure h: 133 mm., lower structure h. 37 mm.)
Upper structure, bell-shaped, completely made in brass.
Finishings available: chrome or gold colour.
This lid fits on the ring for cylinders for carapina.
Lower hermetic structure made in AISI 304 stainless steel, insulated with foam.*



Codice	A mm	B mm	H mm
--------	------	------	------

LAVAPORZIONATORE CARENATO STANDARD PER GELATERIA SCOOP WASHER WITH FAIRING, "STANDARD" VERSION

LVP/CARS	375 (350 interno) (350 internal)	195	270
----------	--	-----	-----

Carenatura angolare in acciaio inox AISI 304, con struttura liscia sui lati.

- completo di foro con raccordo per carico acqua
- vaschetta per lavaporzionario con foro per scarico acqua (1/2"), completa di griglie e tubo troppo pieno

Scoop washer with AISI 304 stainless steel fairing, with even structure on the sides

It includes:

- connector for water filling
- pan with water drain hole (1/2"), separators and overflow pipe

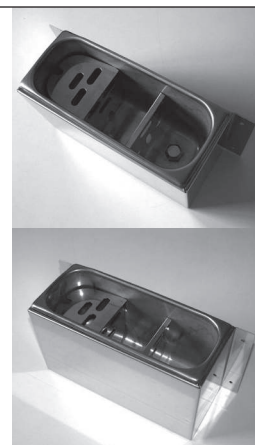

LAVAPORZIONATORE CARENATO ANGOLARE CON RUBINETTO ANGULAR SCOOP WASHER WITH FAIRING AND TAP

LVP/CARG	375 (350 interno) (350 internal)	195	270
----------	--	-----	-----

Carenatura angolare in acciaio inox AISI 304, con struttura liscia sui lati.

- completo di rubinetto carico acqua
- vaschetta per lavaporzionario con foro per scarico acqua (1/2"), completa di griglie e tubo troppo pieno

Scoop washer with AISI 304 stainless steel angular fairing, with even structure on the side.

It includes:

- water tap
- pan with water drain hole (1/2"), separators and overflow pipe



LAVAPORZIONATORE CARENATO DE LUXE PER GELATERIA SCOOP WASHER WITH FAIRING, "DE LUXE" MODEL

LVP/CAR	375 (350 interno) (350 internal)	195	270
---------	--	-----	-----

Carenatura in acciaio inox AISI 304, con angoli arrotondati.

- completo di rubinetto De Luxe regolabile, posizionabile a destra oppure a sinistra
- vaschetta per lavaporzionario con foro per scarico acqua (1/2") completa di griglie e tubo troppo pieno

Scoop washer with AISI 304 stainless steel fairing, with rounded corners.

It includes:

- adjustable water tap. The tap can be placed either on the left or right side of the fairing.
- pan with water drain hole (1/2"), separators and overflow pipe



LAVAPORZIONATORE CARENATO PLATINUM PER GELATERIA SCOOP WASHER WITH FAIRING, "PLATINUM" MODEL

LVP/CARP	375 (350 interno) (350 internal)	195	270
----------	--	-----	-----

Carenatura in acciaio inox AISI 304, con angoli arrotondati.

- completo di rubinetto Platinum regolabile, posizionabile a destra oppure a sinistra
- vaschetta per lavaporzionario con foro per scarico acqua (1/2") completa di griglie e tubo troppo pieno

Scoop washer with AISI 304 stainless steel fairing, with rounded corners. It includes:

- spray rinsing unit. It can be placed either on the left or right side of the fairing.
- pan with water drain hole (1/2"), separators and overflow pipe



Codice	A mm	B mm	H mm
--------	------	------	------

VASCHETTA LAVAPORZIONATORE COMPLETA COMPLETE SCOOP WASHER

A scelta tra due versioni: 1 foro (scarico acqua, 1/2") e due fori (carico, 3/8" e scarico acqua 1/2").

Two versions available:

LVP/ELEM	270 esterno <i>270 external</i>	110 esterno <i>110 external</i>	120
	(251 interno <i>(251 internal)</i>	95 interno <i>95 internal</i>	

Vaschetta 270x110x120 mm. per lavaporzionario.

Un foro per scarico acqua (1/2").

Scoop washer, 270x110x120 mm. with water drain hole (1/2"), separators and overflow pipe



LVP/GRL	270 esterno <i>270 external</i>	110 esterno <i>110 external</i>	120
	(251 interno <i>(251 internal)</i>	95 interno <i>95 internal</i>	

Vaschetta 270x110x120 mm. per lavaporzionario, completa di tubo troppo pieno e griglie inox.

Un foro per scarico acqua (1/2") ed un foro di carico acqua (3/8")

Scoop washer, 270x110x120 mm. with water drain hole (1/2"), connector for water filling (3/8"), separators and overflow pipe

RUBINETTI LAVAPORZIONATORE TAPS FOR SCOOP WASHER

LVP/RUB Rubinetto De Luxe "carico" per lavaporzionario
LVP/RUB Water tap for scoop washer

LVP/SHOWER Rubinetto Platinum "carico" per lavaporzionario
LVP/SHOWER Spray rinsing unit

Accessori su richiesta: plastica per LVP/SHOWER e gomma batti-porzionatore



ACCESSORI LAVAPORZIONATORE ACCESSORIES FOR SCOOP WASHER

TUBO/TP Tubo "troppo pieno" Inox per lavaporzionario
Stainless steel overflow pipe for scoop washer

GRL/LVP Set griglie Inox per lavaporzionario
Stainless steel separators for scoop washer

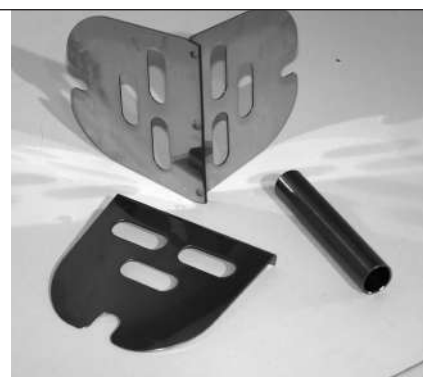

Codice	A mm	B mm	H mm
--------	------	------	------

COPERCHI IN PLEXIGLASS TRASPARENTE VASCHE GELATERIA

PLEXIGLAS FLAT LID FOR ICE-CREAM PANS

CV 03	330	165
CV 04	360	165
CV 07	210	200
CV 08	260	160



COPERCHIO A CUPOLA IN POLICARBONATO

POLYCARBONATE DOME LID

CV 10	360	250
-------	-----	-----

Altezza della cupola 85 mm.
Height of the lid: 85 mm.

CV04 D	360	165
--------	-----	-----

Altezza della cupola 85 mm.
Height of the lid: 85 mm.



COPERCHIO IN ACCIAIO INOX

STAINLESS STEEL LID

CV 09	165	165
-------	-----	-----

CV 09L	360	165
--------	-----	-----



TRAVERSA SOSTEGNO VASCHE

SUPPORT STRUCTURE FOR PANS

TIM/H16	165	165
---------	-----	-----

Struttura di sostegno per due vaschette 165x165x120
This structure supports two 165x165x120 pans

TIM/H18	180	165
---------	-----	-----

Struttura di sostegno per due vaschette 180x165x120
This structure supports two 180x165x120 pans



GRIGLIE GELATI A STECCO

POPSICLES RACK

GR/04 Griglia portagelati a stecco o ghiaccioli, per vaschette 360x165
GR/04 Popsicles rack for 360x165 pans

GR/10 Griglia portagelati a stecco o ghiaccioli, per vaschette 360x250
GR/04 Popsicles rack for 360x250 pans

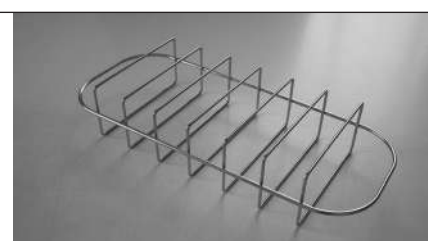

Codice	A mm	B mm	H mm
--------	------	------	------

VASCHE GELATERIA POLICARBONATO TRANSPARENT POLYCARBONATE PAN

VSC04	360 esterno (330 interno)	165 esterno (140 interno)	120
-------	------------------------------	------------------------------	-----

in polycarbonato trasparente (nero a richiesta)

*360 external
(330 internal)* *165 external
(140 internal)*

Black polycarbonato pan available upon request

VSC10	360 esterno (332 interno)	250 esterno (227 interno)	80
-------	------------------------------	------------------------------	----

in polycarbonato trasparente (nero a richiesta)

*360 external
(332 internal)* *250 external
(227 internal)*

Black polycarbonato pan available upon request



SPATOLE GELATERIA INOX STAINLESS STEEL SPATULAS

PLG/26

Spatola da gelateria 260 mm. In acciaio inox 260
con manico colorato in polipropilene

Disponibili nei seguenti colori:

Nero-bianco-rosso-blu-verde-giallo

Stainless steel spatulas, length 260 mm., with polypropilene coloured handle.

Available in the following colours: Black – white – red – blue – green – yellow

PLG/29

Spatola da gelateria 290 mm. In acciaio inox 290
con manico colorato in polipropilene

Disponibili nei seguenti colori:

Bianco – rosso

Stainless steel spatulas, length 290 mm., with polypropilene coloured handle.

Available in the following colours: White – red

PLG/26TRASP

Spatola gelateria 260 mm in acciaio inox, manico in plastica trasparente

Stainless steel spatula, length 260 mm., transparent plastic handle.



SPATOLE PER CARAPINA SPATULAS FOR CARAPINA

PLG00 Spatola inox 200 mm., per carapina

Stainless steel spatula, length 200 mm., for carapina

PLG00P Spatola inox 200 mm. con manico in plastica, per carapina

Stainless steel spatula, length 200 mm., with plastic handle, for carapina



SPATOLA GELATERIA POLICARBONATO CLEAR POLYCARBONATE SPATULA

PLG/26P

Spatola in polycarbonato trasparente 260

Clear polycarbonato spatula, length 260 mm.



PORZIONATORI SCOOPS

Porzionatori in acciaio inox e manico in plastica colorato.

Stainless steel scoops with coloured plastic handle

Diametri disponibili:

28/39/42/44/46/51/61 mm.

Available diameters:

28/39/42/44/46/51/61 mm.



Codice	H cm
--------	------

PORTACONO IN PLASTICA A 2 TUBI
PLASTIC HOLDER FOR ICE-CREAM CONES, TWO PIPES

PRT/P2 93

2 tubi per coni di diametro 6,5 cm

Valvole e coperchi di plastica

Two pipes for ø 6,5 cm ice-cream cones

Plastic plates and lids.



PORTACONO GIREVOLE CROMATO A 6 TUBI
TURNING HOLDER FOR ICE-CREAM CONES, 6 PIPES. CHROME FINISHING

PRT/C6 97

6 tubi per coni di diametro 6,5 cm

Valvole e coperchi di plastica bianchi

Six pipes for ø 6,5 cm ice-cream cones

Plastic plates and white plastic lids.



Codice	H cm
--------	------

PORTACONO GIREVOLE OTTONATO A 6 TUBI*TURNING HOLDER FOR ICE-CREAM CONES, 6 PIPES. CHROME FINISHING*

PRT/O6 110

finitura cromo

6 tubi per coni di diametro 6,5 cm

Valvole con lamelle in bronzo

*Chrome finishing**Six pipes for ø 6,5 cm ice-cream cones**Brass plates*

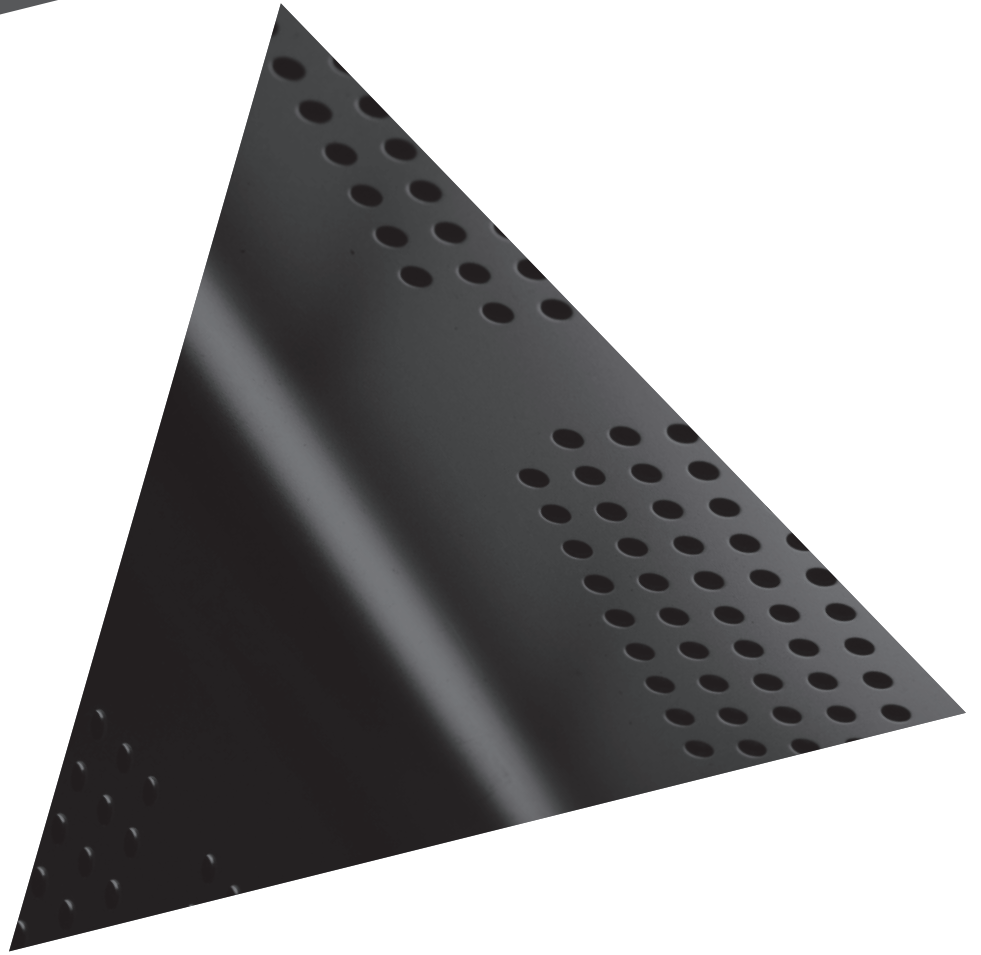
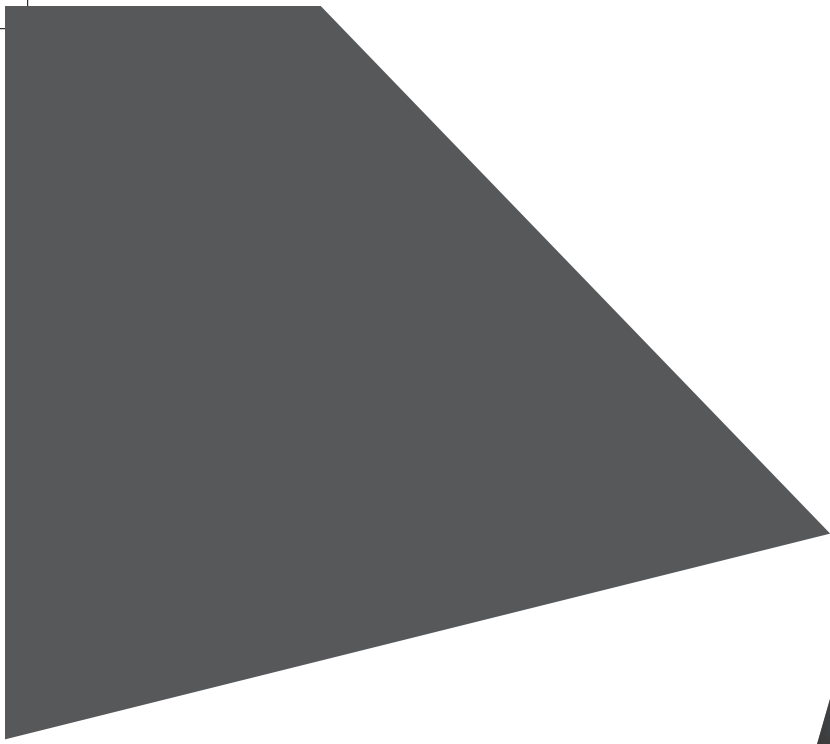



Gastronomia

Gastronorm

Benvenuti nel mondo Gastronorm di Asit.

Vi proponiamo contenitori GN di tutte le misure, sia in acciaio inox e in polycarbonato con i relativi coperchi.

Su ogni contenitore GN a richiesta è inoltre possibile applicare anche maniglie retrattili.

Contenitori GN forati, teglie a bordo piano, falsi fondi forati e molto altro ancora.

Welcome to ASIT world of Gastronorm.

We propose Gastronorm containers of all the sizes, both in stainless steel and in polycarbonate, with their lids.

It is also possible to apply retractable handles on every Gastronorm container.

We offer also perforated containers, baking pans, drainer plates and many more.

Codice	A mm	B mm	H mm	Litri
--------	------	------	------	-------

CONTENITORI GASTRONORM IN ACCIAIO INOX 18/10 STAINLESS STEEL GASTRONORM PANS

GST2/1	650 esterno	530 esterno	20	8 lt
	(625 interno)	(505 interno)	40	11 lt
			65	18.4 lt
			100	28.9 lt
			150	43.4 lt
			200	57.5 lt
	<i>650 external</i>	<i>530 external</i>		
	<i>(625 internal)</i>	<i>(505 internal)</i>		



GST1/1	530 esterno	325 esterno	20	2 lt
	(505 interno)	(300 interno)	40	5.1 lt
			65	8.5 lt
			100	13.3 lt
			150	20 lt
			200	26.5 lt
	<i>530 external</i>	<i>325 external</i>		
	<i>(505 internal)</i>	<i>(300 internal)</i>		



GST1/2	325 esterno	265 esterno	20	1 lt
	(300 interno)	(240 interno)	40	2.3 lt
			65	3.8 lt
			100	6 lt
			150	8.9 lt
			200	11.7 lt
	<i>325 external</i>	<i>265 external</i>		
	<i>(300 internal)</i>	<i>(240 internal)</i>		



GST1/3	325 esterno	176 esterno	20	0.3 lt
	(300 interno)	(151 interno)	40	1.4 lt
			65	2.4 lt
			100	3.8 lt
			150	5.5 lt
			200	7.5 lt
	<i>325 external</i>	<i>176 external</i>		
	<i>(300 internal)</i>	<i>(151 internal)</i>		



Codice	A mm	B mm	H mm	Litri
--------	------	------	------	-------

GST1/4	265 esterno (240 interno)	162 esterno (137 interno)	20	0.4 lt
			65	1.7 lt
			100	2.7 lt
			150	4 lt
			200	5.2 lt

*265 external
(240 internal)* *162 external
(137 internal)*



GST1/6	176 esterno (151 interno)	162 esterno (137 interno)	65	1 lt
			100	1.6 lt
			150	2.2 lt
			200	3 lt

*176 external
(151 internal)* *162 external
(137 internal)*



GST1/9	176 esterno (151 interno)	108 esterno (83 interno)	65	0.6 lt
			100	0.9 lt

*176 external
(151 internal)* *108 external
(83 internal)*



GST2/3	354 esterno (329 esterno)	325 esterno (300 interno)	20	1.5 lt
			40	3.3 lt
			65	5.4 lt
			100	8.5 lt
			150	12.7 lt
200	16.7 lt			

*354 external
(329 internal)* *325 external
(300 internal)*



GST2/4	530 esterno (505 interno)	162 esterno (137 interno)	20	1 lt
			40	2.3 lt
			65	4 lt
			100	6 lt
			150	9 lt

*530 external
(505 internal)* *162 external
(137 internal)*



Codice	A mm	B mm	H mm
--------	------	------	------

CONTENITORI GASTRONORM IN POLICARBONATO POLYCARBONATE GASTRONORM PANS

GSTP	GST2/1P	GST1/3P
	GST1/1P	GST1/4P
	GST1/2P	GST1/6P GST1/9P

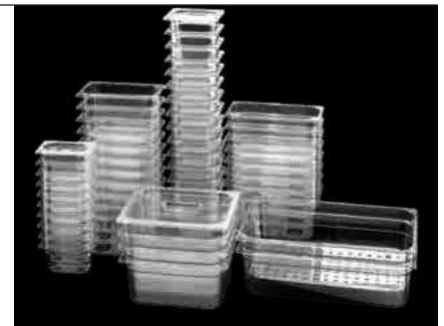

Per maggiori dettagli si rimanda all'apposita sezione Policarbonato
For further details, please see Polycarbonate section

COPERCHI IN ACCIAIO INOX PER CONTENITORI GASTRONORM STAINLESS STEEL LIDS FOR GASTRONORM PANS

CPR	1/1	1/2
	1/3	1/4
	1/6	1/9
	2/3	2/4



COPERCHI IN POLICARBONATO PER CONTENITORI GASTRONORM POLYCARBONATE LIDS FOR GASTRONORM PANS

CPRP	1/1P	1/2P	2/1P
	1/3P	1/4P	
	1/6P	1/9P	



SCHEMA CONTENITORI GASTRONORM

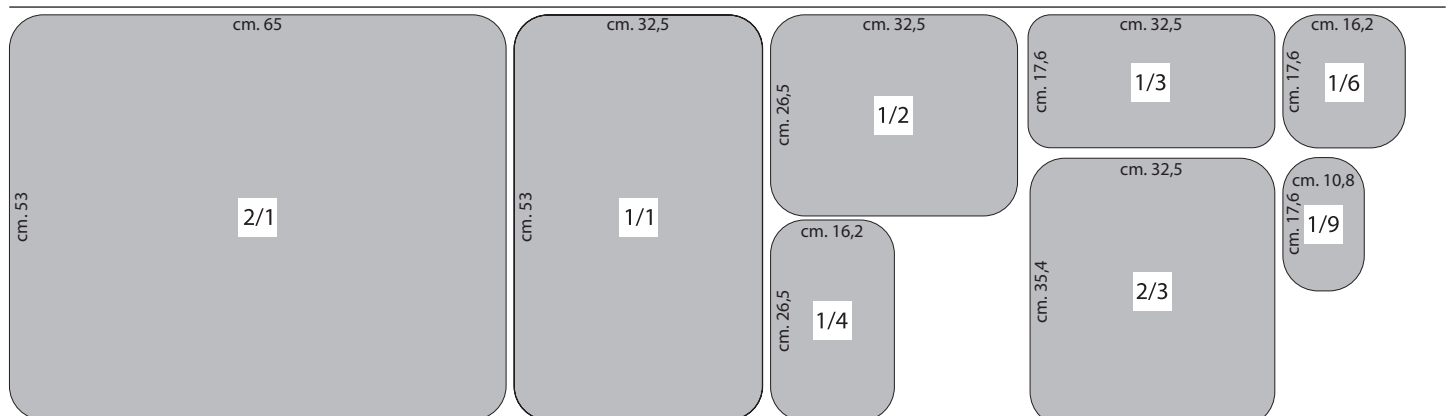

Codice	A mm	B mm	H mm
--------	------	------	------

CONTENITORI GASTRONORM IN ACCIAIO INOX 18/10 – FORATI
PERFORATED GASTRONORM PANS

GST2/1F	650 esterno	530 esterno	20
	(625 interno)	(505 interno)	40
			65
	<i>650 external</i>	<i>530 external</i>	
	<i>(625 internal)</i>	<i>(505 internal)</i>	
Diametro fori 4 mm			100
<i>Diameter of holes:</i>			
fori sul fondo:			20 - 40 - 65
<i>holes on bottom:</i>			
fori sul fondo e lato:			100 - 150 - 200
<i>holes on bottom and side:</i>			



GST1/1F	530 esterno	325 esterno	20
	(505 interno)	(300 interno)	40
			65
	<i>530 external</i>	<i>325 external</i>	
	<i>(505 internal)</i>	<i>(300 internal)</i>	
Diametro fori 4 mm			100
<i>Diameter of holes:</i>			
fori sul fondo:			20 - 40 - 65
<i>holes on bottom:</i>			
fori sul fondo e lato:			100 - 150 - 200
<i>holes on bottom and side:</i>			



GST2/3F	354 esterno	325 esterno	20
	(329 esterno)	(300 interno)	40
			65
	<i>354 external</i>	<i>325 external</i>	
	<i>(329 internal)</i>	<i>(300 internal)</i>	
Diametro fori 4 mm			100
<i>Diameter of holes:</i>			
fori sul fondo:			20 - 40 - 65
<i>holes on bottom:</i>			
fori sul fondo e lato:			100 - 150 - 200
<i>holes on bottom and side:</i>			

TEGLIE GASTRONORM IN ACCIAIO INOX 18/10 – A BORDO PIANO
GASTRONORM BAKING PANS – AISI 304 STAINLESS STEEL

FNC2/1	650 esterno	530 esterno	20
	(625 interno)	(505 interno)	40
			65
	<i>650 external</i>	<i>530 external</i>	
	<i>(625 internal)</i>	<i>(505 internal)</i>	
FNC1/1	530 esterno	325 esterno	20
	(505 interno)	(300 interno)	40
			65
	<i>530 external</i>	<i>325 external</i>	
	<i>(505 internal)</i>	<i>(300 internal)</i>	
FNC2/3	354 esterno	325 esterno	20
	(505 interno)	(300 interno)	40
			65
	<i>354 external</i>	<i>325 external</i>	
	<i>(329 internal)</i>	<i>(300 internal)</i>	



Codice	A mm	B mm	H mm
--------	------	------	------

A RICHIESTA UPON REQUEST

APPLICAZIONE MANIGLIE RETRATTILI SU TUTTI I MODELLI gamma e dimensioni come da serie Acciaio Inox

APERTURA PER MANIGLIE SU COPERCHI

APERTURA PER MESTOLO SU COPERCHI

Application of retractable handles on all the models (see stainless steel Gastronorm section)

Slot for handles on lids

Slot for spoon on lids



COPERCHI CON GUARNIZIONI A TENUTA LIDS WITH SILICONE GASKET

CPR/T	1/1
Guarnizione al silicone	1/2
per uso alimentare:	1/3
completi di foro	1/4
di compensazione	1/6

Silicone gasket



GRIGLIE IN ACCIAIO INOX 18/10 STAINLESS STEEL GRIDS

GSTGR2I	650	530	per GST2/1
GSTGR1I	530	325	per GST1/1

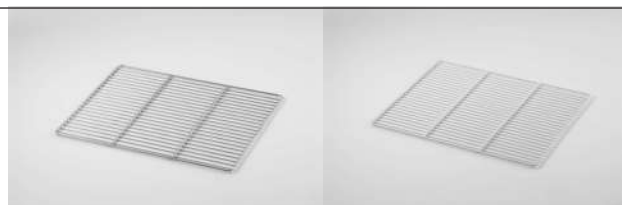

GRIGLIE IN POLICARBONATO POLYCARBONATE GRIDS

GSTGR2	650	530	per GST2/1
GSTGR1	530	325	per GST1/1

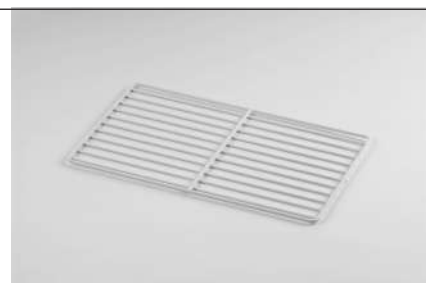

Codice A mm

FALSI FONDI FORATI

DRAINER PLATES

GSTFF11	in acciaio inox	per GST1/1	fori ø 10 mm
GSTFF12	in acciaio inox	per GST1/2	fori ø 10 mm
GSTFF23	in acciaio inox	per GST2/3	fori ø 10 mm
GSTFF11P	polycarbonato	per GST1/1	fori ø 10 mm
GSTFF12P	polycarbonato	per GST1/2	fori ø 10 mm
	<i>in stainless steel</i>	<i>for GST1/1</i>	<i>holes ø 10 mm.</i>
	<i>in stainless steel</i>	<i>for GST1/2</i>	<i>holes ø 10 mm.</i>
	<i>in stainless steel</i>	<i>for GST2/3</i>	<i>holes ø 10 mm.</i>
	<i>in polycarbonate</i>	<i>for GST1/1</i>	<i>holes ø 10 mm.</i>
	<i>in polycarbonate</i>	<i>for GST1/2</i>	<i>holes ø 10 mm.</i>

Per maggiori dettagli si rimanda all'apposita sezione Polycarbonato
 For further details, please see Polycarbonate section

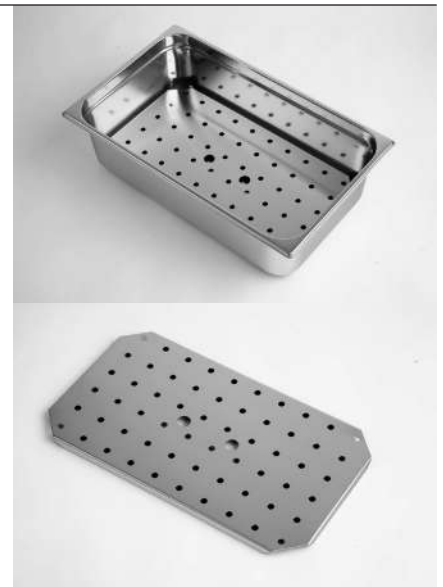

TRAVERSE INTERMEDIE

ADAPTOR BARS

TIM26	265mm
TIM325	325mm
TIM53	530mm



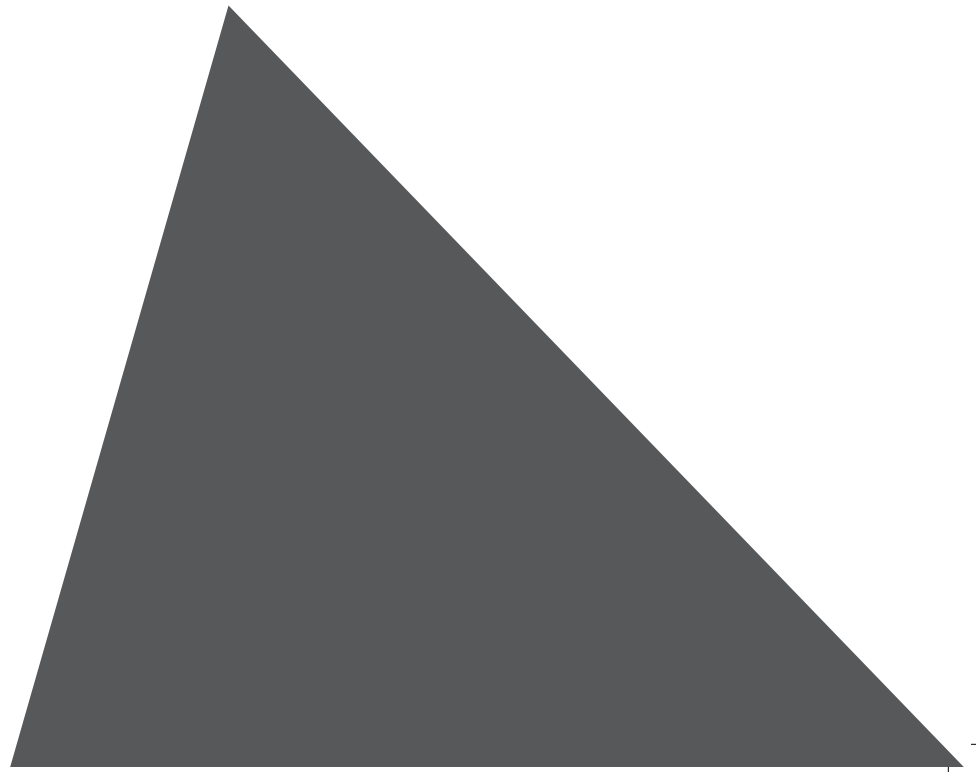
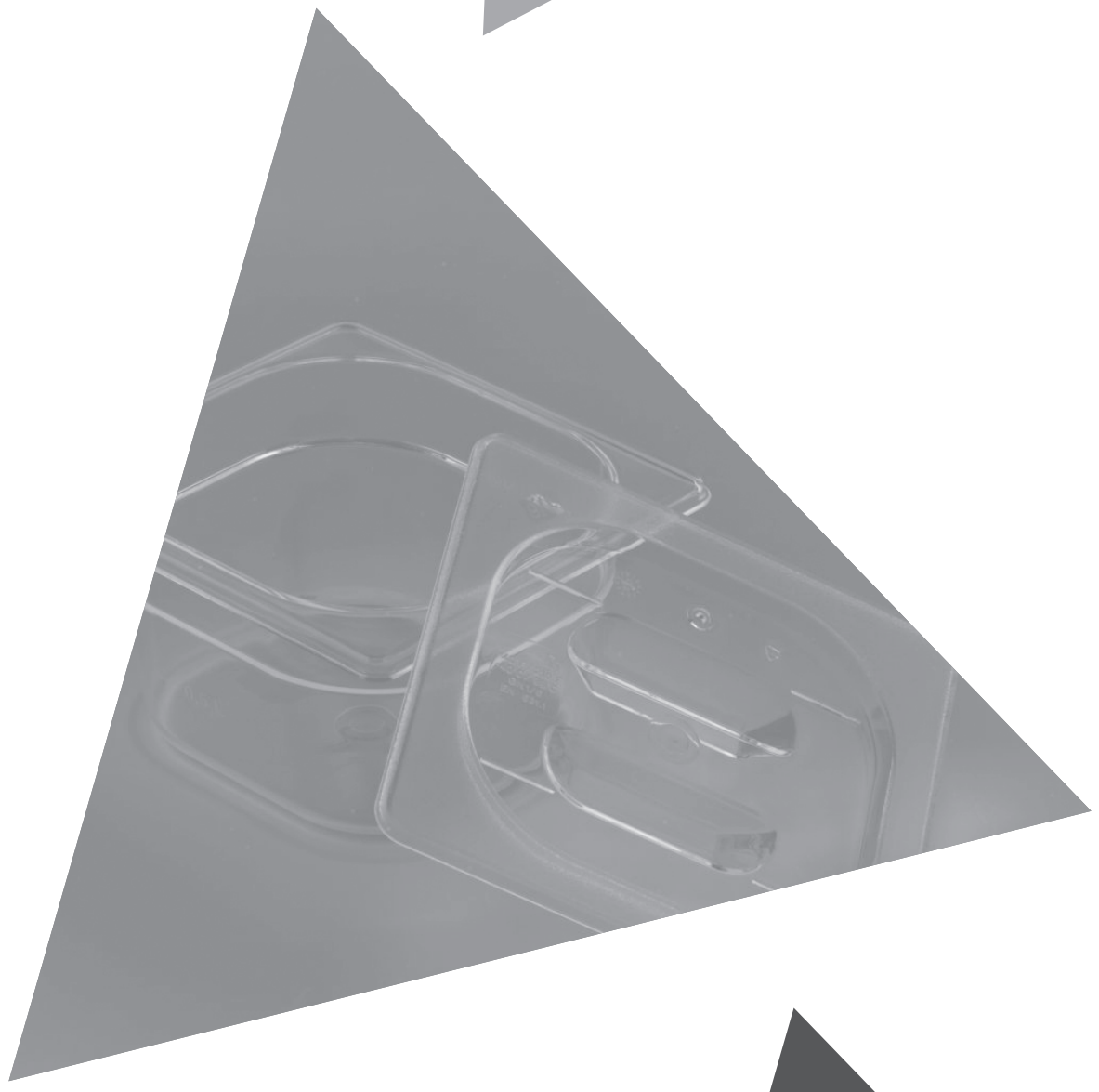

Policarbonato

Polycarbonate

Tutti i contenitori, sia da gelateria che gastronom, hanno una doppia vita: in acciaio inox oppure in policarbonato.

Non solo: troverete anche coperchi GN, coperchi da gelateria e falsi fondi forati.

Il policarbonato contribuisce a fornire una elevata resistenza agli urti e al tempo stesso una leggerezza che rende i prodotti estremamente pratici e funzionali.

Particolarmente resistente alle basse temperature, arriva a sopportare una temperatura di esercizio per lunghi periodi fino a -40°C .

All of the containers, both for ice cream and Gastronom, have a double life: stainless steel or polycarbonate.

But not only that: you will also find Gastronom lids, ice-cream containers lids and drainer plates.

The polycarbonate provides a high resistance to shocks and at the same time a lightness that makes the products extremely practical and functional.

Since it is very resistant to low temperatures, this material can bear an operating temperature, for long periods, up to -40°C .

Codice	A mm	B mm	H mm	Litri
--------	------	------	------	-------

CONTENITORI GASTRONORM IN POLICARBONATO
POLYCARBONATE GASTRONOM PANS

GST2/1P	650 esterno	530 esterno	200	57.5 lt
	(625 interno)	(505 interno)		
	<i>650 external</i>	<i>530 external</i>		
	<i>(625 internal)</i>	<i>(505 internal)</i>		

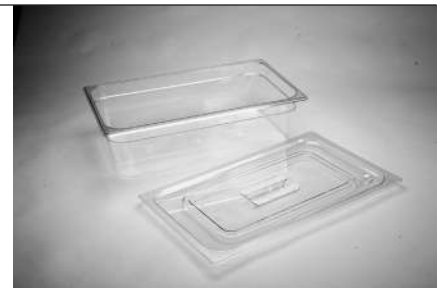

GST1/1P	530 esterno	325 esterno	65	8.5 lt
	(505 interno)	(300 interno)	100	13.3 lt
			150	20 lt
			200	26.5 lt
	<i>530 external</i>	<i>325 external</i>		
	<i>(505 internal)</i>	<i>(300 internal)</i>		



GST1/2P	325 esterno	265 esterno	65	3.8 lt
	(300 interno)	(240 interno)	100	6 lt
			150	8.9 lt
			200	11.7 lt
	<i>325 external</i>	<i>265 external</i>		
	<i>(300 internal)</i>	<i>(240 internal)</i>		



POLICARBONATO

Codice	A mm	B mm	H mm	Litri
--------	------	------	------	-------

GST1/3P	325 esterno	176 esterno	65	2.4 lt
	(300 interno)	151 interno)	100	3.8 lt
			150	5.5 lt
			200	7.5 lt
	<i>325 external</i>	<i>176 external</i>		
	<i>(300 internal)</i>	<i>151 internal)</i>		



GST1/4P	265 esterno	162 esterno	65	1.7 lt
	(240 interno)	137 interno)	100	2.7 lt
			150	4 lt
			200	5.2 lt
	<i>265 external</i>	<i>162 external</i>		
	<i>(240 internal)</i>	<i>137 internal)</i>		



GST1/6P	176 esterno	162 esterno	65	1 lt
	(151 interno)	137 interno)	100	1.6 lt
			150	2.2 lt
			200	3 lt
	<i>176 external</i>	<i>162 external</i>		
	<i>(151 internal)</i>	<i>137 internal)</i>		



GST1/9P	176 esterno	108 esterno	65	0.6 lt
	(151 interno)	83 interno)	100	0.9 lt
	<i>176 external</i>	<i>108 external</i>		
	<i>(151 internal)</i>	<i>83 internal)</i>		



Codice	A mm	B mm
--------	------	------

COPERCHI IN POLICARBONATO PER CONTENITORI GASTRONORM *POLYCARBONATE LIDS FOR GASTONORM PANS*

CPRP 1/1	CPRP 1/2
CPRP 1/3	CPRP 1/4
CPRP 1/6	CPRP 1/9
	CPRP 2/1

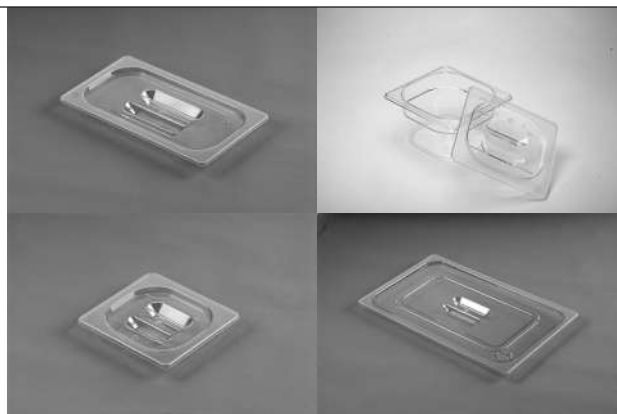

FALSI FONDI FORATI IN POLICARBONATO *POLYCARBONATE DRAINER PLATES*

GSTFF11P	per GST1/1	fori ø 10 mm
<i>Drainer plates for GST 1/1</i>		<i>holes ø 10 mm</i>

GSTFF12P	per GST1/2	fori ø 10 mm
<i>Drainer plates for GST 1/2</i>		<i>holes ø 10 mm</i>



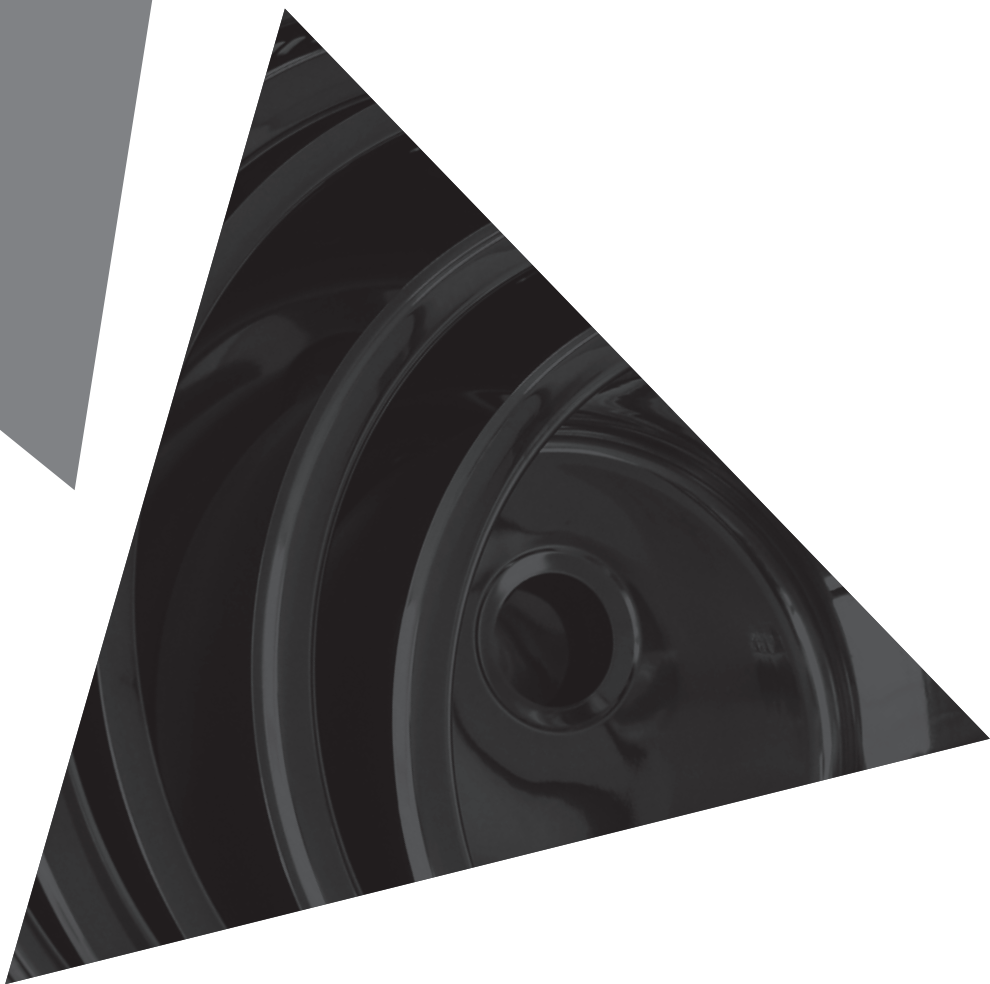



Lavelli

Sink bowls

La dicotomia porta a dover scegliere tra 2 opzioni: bianco o nero.

Nel caso dei lavelli Asit la prima dicotomia che vi chiediamo è: bordo piano a saldare o bordo appoggio ad incasso?

Successivamente potrete scegliere tra forme quadrate, rettangolari o rotonde, disponibili in varie misure.

Completano la gamma tutti gli accessori quali pilette, troppo-pieno e sifoni.

The dichotomy leads to having to choose between two options: black or white.

In the case of Asit sinks, the first dichotomy we ask you is: flat edge or bearing edge?

You may then choose between square, rectangular or round shapes, available in various sizes.

The range is completed by all accessories, such as siphons and waste fittings.

Codice	LATO mm	PROF mm
--------	---------	---------

LAVELLI INOX PER BANCO BAR
STAINLESS STEEL BOWLS FOR BAR COUNTERS

LV042	Ø 420	180
LV038	Ø 380	180
LV036	Ø 360	180
LV030	Ø 300	180
LV026	Ø 260	180



Tutta la serie di lavelli rotondi è disponibile in due versioni

- con bordo piano (a saldare)
- con bordo appoggio (a incasso)

All the range of round bowls is available in two versions:

- flat edge or embedding edge



Codice	LATO mm	PROF mm
--------	---------	---------

LV33/23	335X235	180
---------	---------	-----

Disponibile solo con bordo appoggio (a incasso)
Available only with embedding edge

LV33/33	330X330	200
---------	---------	-----

Disponibile nelle versioni
 • con bordo piano (a saldare)
 • con bordo appoggio (a incasso)
*Available in two versions,
 • flat edge or embedding edge*



Lavello destro

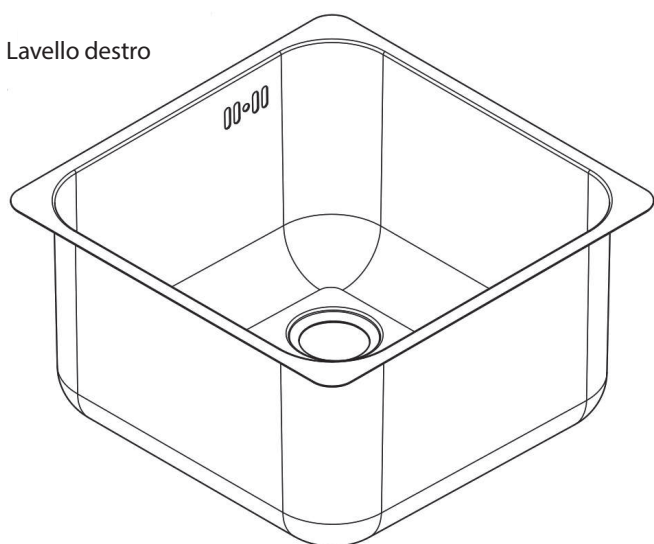

Lavello sinistro

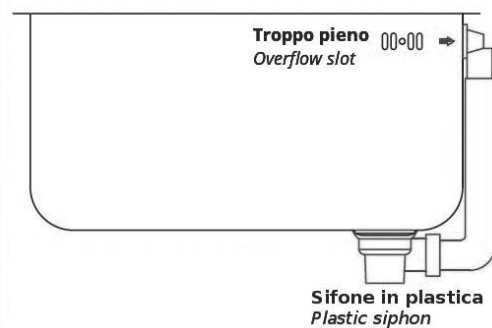
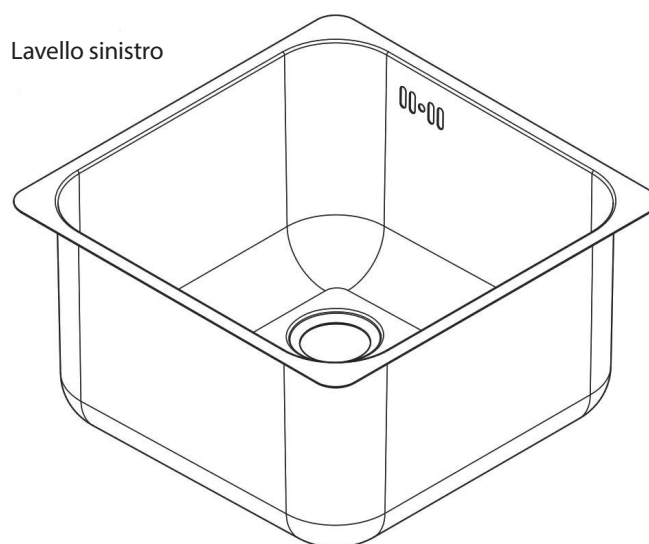

Codice	LATO mm	PROF mm
--------	---------	---------

VASCHE LAVAGGIO

SINK BOWLS

LV34/40/20	340X400	200
LV40/40/20	400X400	200
LV40/40/25	400X400	250
LV40/40/30	400X400	300
LV45/45/20	450X450	200
LV45/45/25	450X450	250
LV45/45/30	450X450	300
LV50/50/25	500X500	250
LV50/50/30	500X500	300
LV60/50/30	500X500	300



Novità!

Il lavello 40/40/20 è disponibile anche nella versione ad incasso (cod. LV40/40/20A)

New!

The 400x400x200 sink bowl is also available in the version with embedding edge.

LV/PIL Piletta/Sifone in plastica per lavello
PVC syphon with waste fitting for round bowls



PIL20 Piletta e tubo T.P. In acciaio inox H 200mm
Overflow pipe with waste fitting for sink bowls (height 200 mm.)

PIL25 Piletta e tubo T.P. In acciaio inox H 250mm
Overflow pipe with waste fitting for sink bowls (height 250 mm.)

PIL30 Piletta e tubo T.P. In acciaio inox H 300mm
Overflow pipe with waste fitting for sink bowls (height 300 mm.)



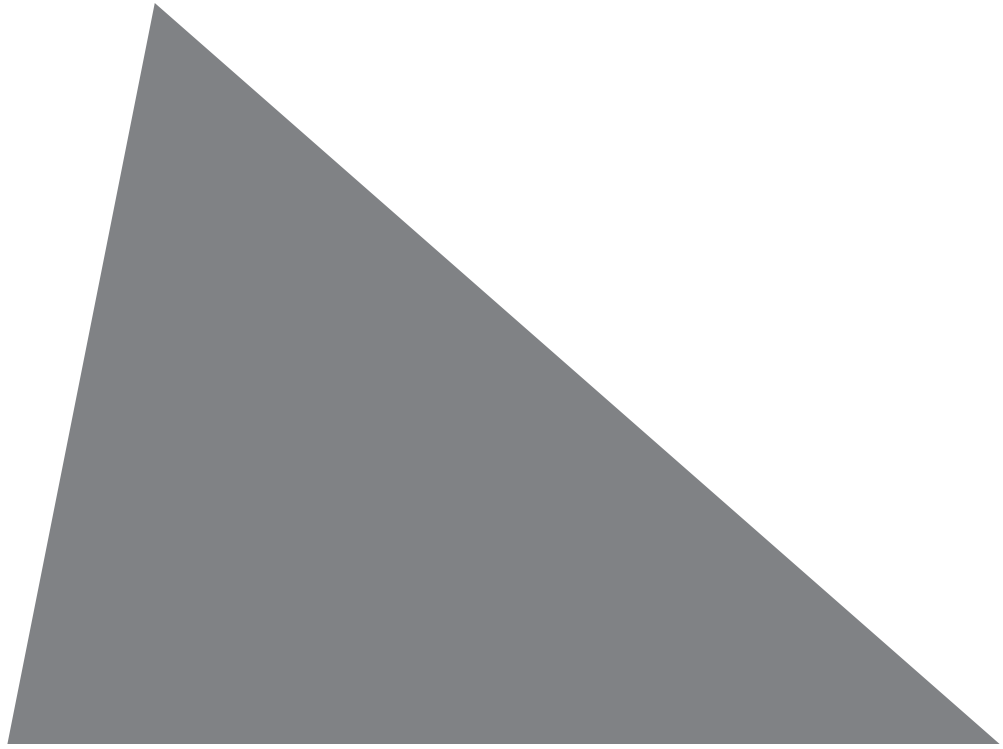
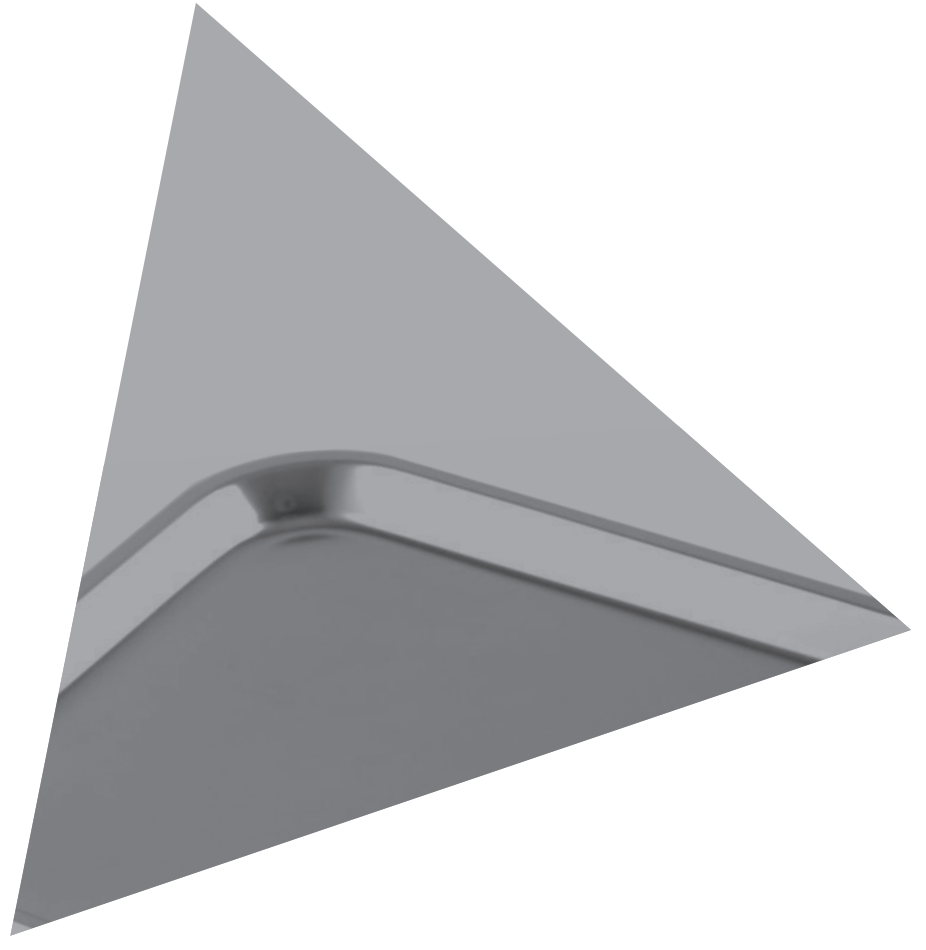



Vassoi

Trays

Vassoi rettangolari sia da esposizione che da trasporto, disponibili sia in acciaio inox che in alluminio.

Vassoi speciali caratterizzati da bordi con risvolti, ideati per l'esposizione su banchi inclinati.

Differenti colorazioni a scelta per le Collezioni di articoli in alluminio.

*R*ectangular trays for display and transport, available both in stainless steel and aluminum.

Special trays with bent edges, designed to fit in inclined display cases.

Different colours to choose from for aluminum items.

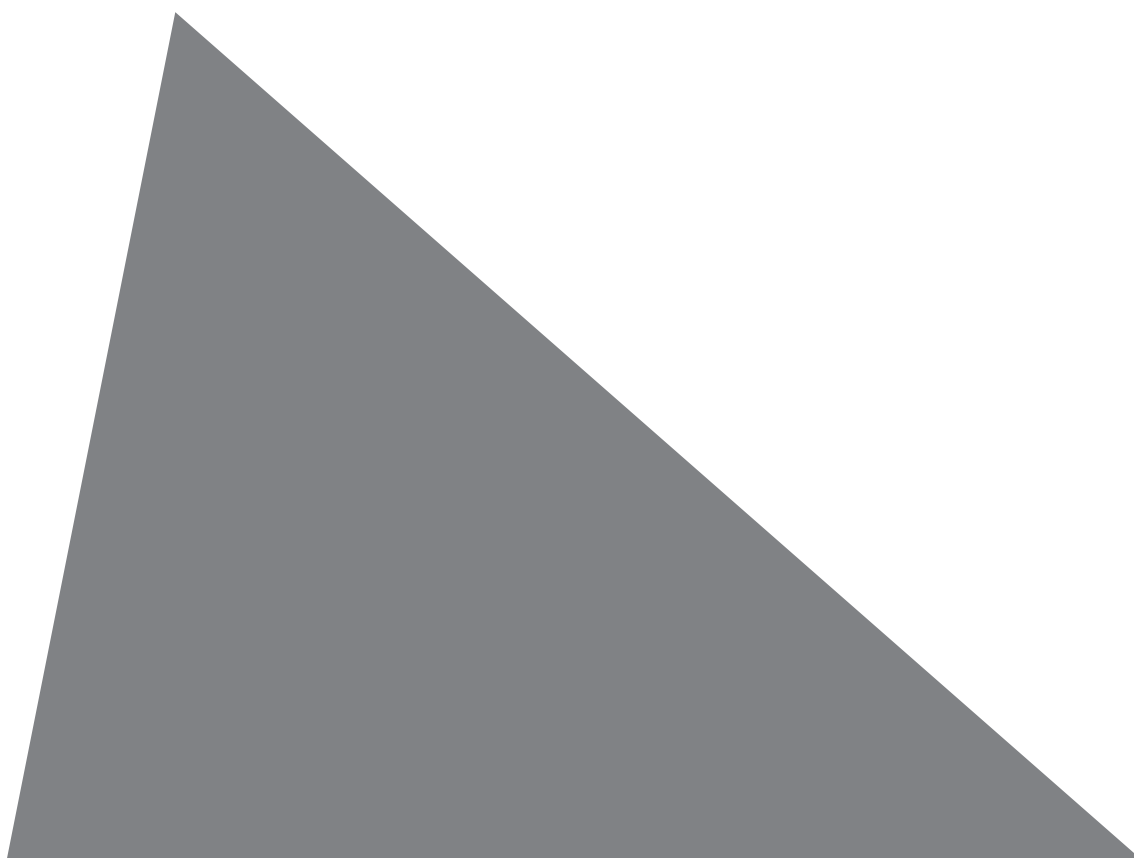

Codice	A mm	B mm	H mm
--------	------	------	------

VASSOI RETTANGOLARI IN ACCIAIO INOX
STAINLESS STEEL RECTANGULAR TRAYS

VSS1	265	195	20
------	-----	-----	----



VSS2	315	235	20
------	-----	-----	----



VSS3	365	265	20
------	-----	-----	----



VSS4	415	300	20
------	-----	-----	----



VSS5	465	315	20
------	-----	-----	----



VASSOI RETTANGOLARI IN ALLUMINIO ANODIZZATO
RECTANGULAR TRAYS - ANODIZED ALUMINUM

VSS32	300	200	10
-------	-----	-----	----



VSS43	400	300	10
-------	-----	-----	----



Codice	A mm	B mm	H mm
--------	------	------	------

VSS64	600	400	10
-------	-----	-----	----



VSS62	600	200	10
-------	-----	-----	----



VSS43i	400	280	10
--------	-----	-----	----

Bordi con risvolta per espositori inclinati
Tray with one bent edge, for inclined display cases.

La serie vassoi in alluminio ASIT è disponibile
 con anodizzazione "Champagne" (oro) oppure "Argento"
The trays range in aluminum is available in either "gold" or "silver" anodization.



VASSOI RETTANGOLARI IN ALLUMINIO NATURALE RECTANGULAR TRAYS IN NATURAL ALUMINUM

VSS3632	360	320	10
---------	-----	-----	----



VSS4332	430	320	10
---------	-----	-----	----



VASSOI MENSA IN ACCIAIO INOX TRAYS FOR CANTEENS

VSSM4	300	400	30
-------	-----	-----	----

Vassoio mensa a 4 scomparti
Trays for canteens, 4 compartments



VSSM5	350	440	30
-------	-----	-----	----

Vassoio mensa a 5 scomparti
Trays for canteens, 5 compartments



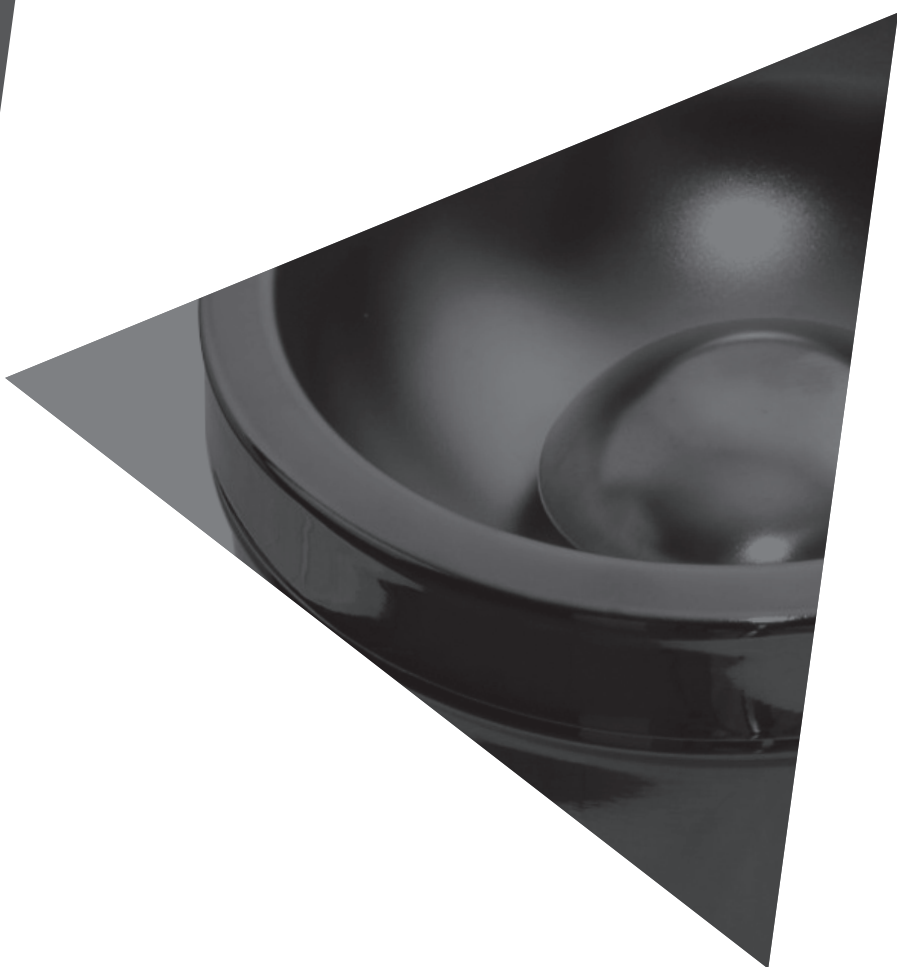
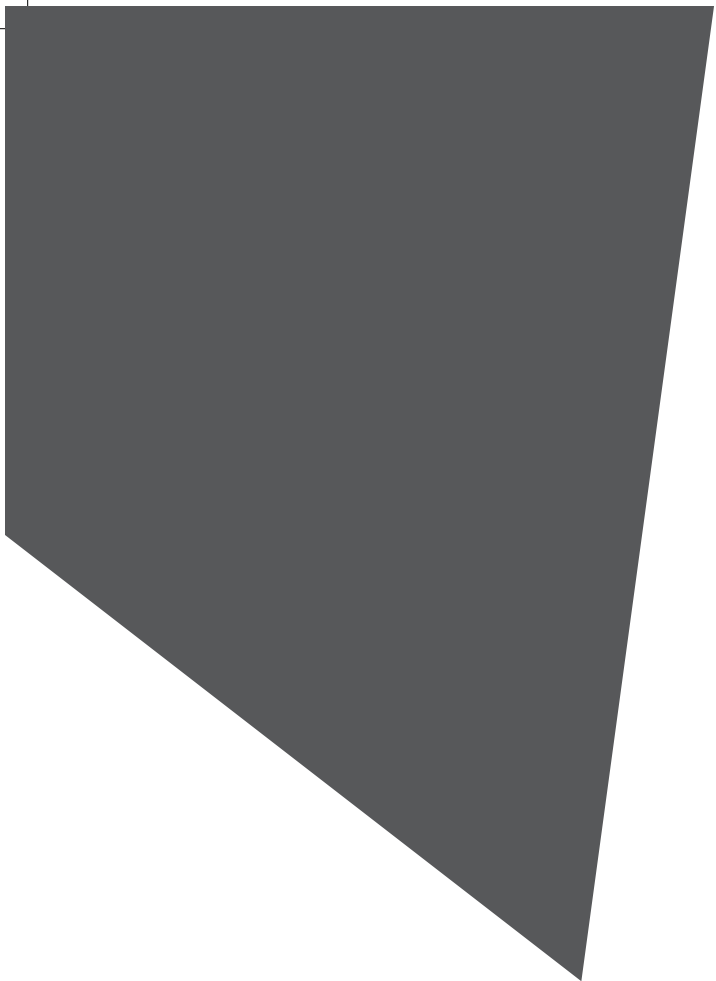

Complementi

Accessories

I complementi si articolano in diverse tipologie di prodotti.

Vi proponiamo carrelli tecnici da asporto, a 2 o 3 piani ed in differenti misure, a scelta tra le versioni saldato o smontabile.

Ancora su ruote la collezione dedicata a tramogge carrellate, pattumiere e portasacchi.

The accessories are divided in different categories.

We offer you technical carts, with either two or three shelves and in different sizes, and the possibility to choose between the welded or mountable version.

Also, a collection dedicated to hoppers, dustbins and garbage bag holders.

Codice	A mm	B mm	H mm	Ripiani
--------	------	------	------	---------

CARRELLI DA ASPORTO E SGOMBERO IN ACCIAIO INOX 18-10
TECHNICAL CARTS IN STAINLESS STEEL

CS80/502	800	500	935	2
CS80/503	800	500	935	3
CS100/502	1000	600	935	2
CS100/503	1000	600	935	3
CS60/442	600	442	935	2
CS60/443	600	442	935	3

Disponibili sia in versione saldata che smontabile

Tutti i carrelli di trasporto e di sgombero sono accessoriati di serie con ripiani insonorizzati, paraurti di protezione e ruote snodate di cui due con freno, bulloni completamente a scomparsa nei piani, grazie ad una soluzione tecnica studiata dal nostro Ufficio Tecnico.

The carts are available both in the welded version and mountable version.

All the carts have soundproof tiers, bumpers and castors.

The bolts are hidden in the tiers, thanks to a solution found by our head technician.



Sono possibili personalizzazioni su tutti i carrelli con i seguenti accessori:

• Cassetti



• Portabacinelle inox



• Tramogge



The carts can be customized with these accessories:

- Drawers
- Support for pans
- Hoppers

Codice	Litri	Ø mm	H mm
--------	-------	------	------

PATTUMIERE CARRELLATE ROTONDE INOX
ROUND DUSTBINS WITH CASTORS

PT50	50	380	605
pattumiera inox con ruote <i>Round dustbins with castors</i>			
PT75	75	450	605
pattumiera inox con ruote <i>Round dustbins with castors</i>			
PT90	90	450	685
pattumiera inox con ruote <i>Round dustbins with castors</i>			

PATTUMIERE CARRELLATE ROTONDE INOX CON APERTURA A PEDALE
ROUND DUSTBINS WITH CASTORS AND PEDAL

PT50P	50	380	605
pattumiera apertura a pedale <i>Round dustbins with castors</i>			
PT75P	75	450	605
pattumiera apertura a pedale <i>Round dustbins with castors</i>			
PT90P	90	450	685
pattumiera apertura a pedale <i>Round dustbins with castors</i>			

PORTASACCO INOX PEDALE
GARBAGE BAG HOLDER

PSACCO	450	850
Portasacco inox con ruote apertura a pedale <i>Garbage bag holder with castors and pedal</i>		

TRAMOGGE CARRELLATE INOX
HOPPER ON WHEELS

TM115	115	395x610x725
TM135	135	395x700x725

Contenitore carrellato completamente in acciaio inox con fondo stampato e saldato a tenuta, con coperchio incernierato centralmente interamente amovibile. Su richiesta è possibile inserire un divisorio interno.
Hopper in stainless steel with welded bottom, hermetic. The lid can be removed. It is possible to add an internal divider, upon request.



Codice

SPUTACCHIERA
WINE SPITTOON

ENO

Sputacchiera professionale
in acciaio inox 18/10 – AISI 304.
Lavabile in lavastoviglie,
possibili personalizzazioni

Diametro: mm. 120 Altezza: mm. 150
Capacità: 1,7 lt

*Professional wine spittoon,
manufactured in stainless steel.
It can be washed into the dishwasher.
Customizations possible.*

*Ø diameter: mm. 120 Height: mm. 150
Capacity: 1,7 lt*





Idee e forme in acciaio inox

Asit ricorda che tutti gli articoli inox sono rigorosamente realizzati con Acciaio Inox AISI 304 di origine Europea.

Asit would also like to remind that all the stainless steel items are made entirely with AISI 304 stainless steel of European origin.

Gelateria
Ice-cream

Gastronomia
Gastronorm

Policarbonato
Polycarbonate

Lavelli
Sink bowls

Vassoi
Trays

Complementi
Accessories



Via di Collandino, 190
53014 Monteroni d'Arbia
Siena - Italy

Tel. +39 0577 373219
Fax +39 0577 373220

info@asit-italia.it
www.asit-italia.it